

NeoWall

design Piero Lissoni

Different modular elements. Frame in double-paneled poplar and pine. Cross-woven, coated rubber elastic straps. Padding in differentiated density polyurethane foam covered with a quilted mat in prewashed and sterilized goose down, stitched into separated compartments or in differentiated density polyurethane foam and visco-soft "Xtra-pur" covered with acrylic fibre layers. Black adjustable PVC feet or in stainless steel, with matt satin-finish. Fabric or leather upholstery, both fully removable by Velcro fastenings. The various elements are joined together by means of hooks. Seat depth 68-94cm.



Seat 68x68

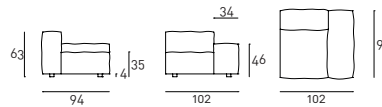
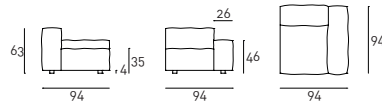
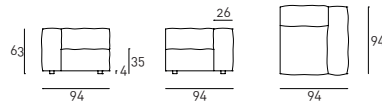
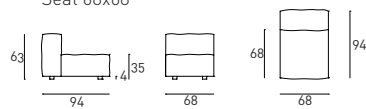

Seat 94x68

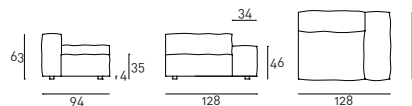
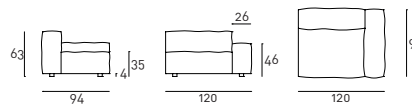
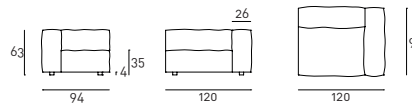
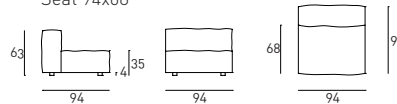

Seat 127x68

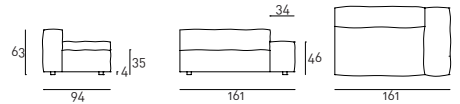
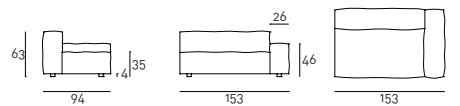
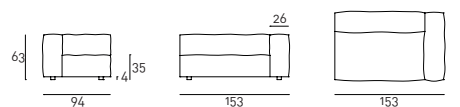
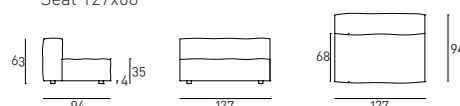

LIVING

D I V A N I

Seat 94x94

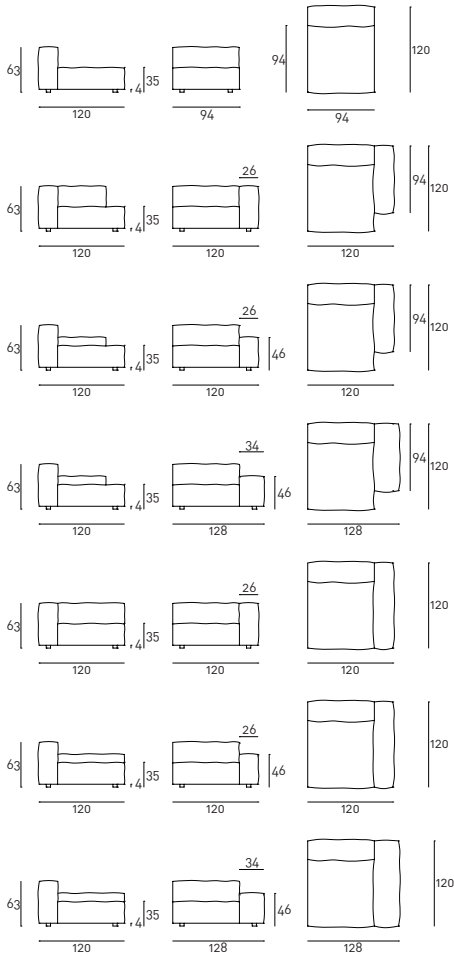

Seat 127x94

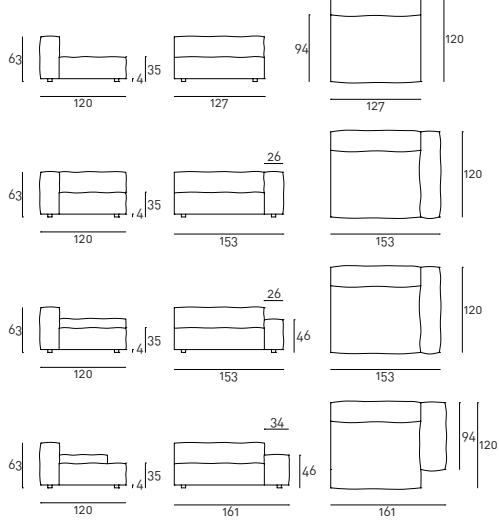

Long seat

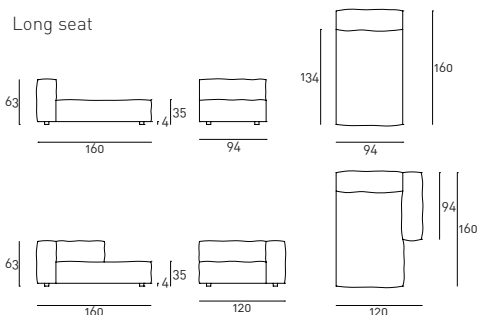

NeoWall

design Piero Lissoni

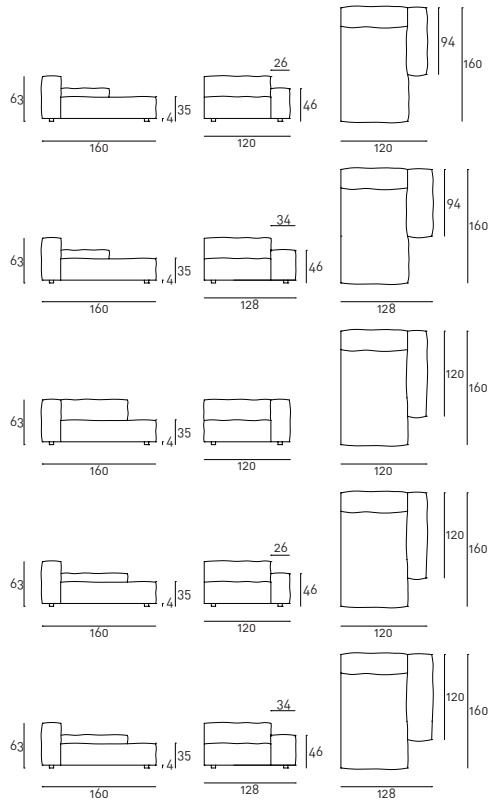

Corner element

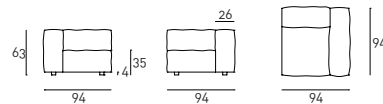

Footrests

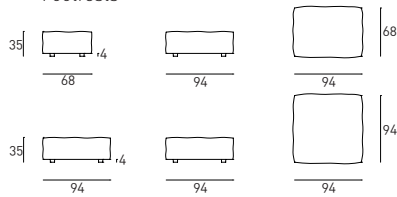

Standard foot PVC

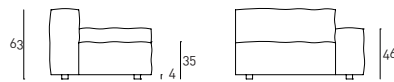

Foot in stainless steel AISI 304 satin-finish

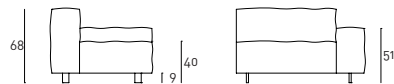

Cushions

