

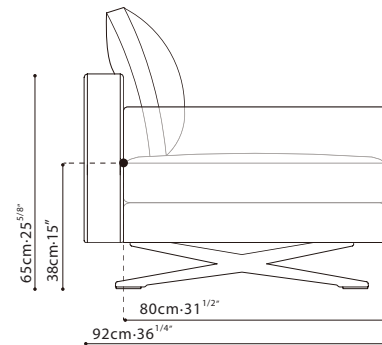

WAKE / FRAME: : Constructed in solid birch, paired with cross-woven elastic webbing. Frame is also covered with polyurethane foam and fabric lining. **CUSHIONS:** Seat cushions consist of high-resilient polyurethane foam, topped with feather down and polyester fiber. Back cushions are filled with feather down and polyester fiber. Throw cushion, C81D0204, is filled with feather down. Daybed bolster is filled with polyurethane foam. All cushions have hidden zipper closing. **LEGS:** Steel legs are finished in black metallic paint and capped with plastic glides. **UPHOLSTERY:** Fabric, (removable via Velcro), or leather.



FABRIC VERSION

C01D0201



C01D0202



C01D0203

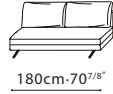

C01D0204

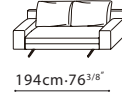

C01D0205

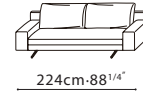

C01D0206

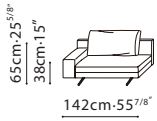

C01D0207



C01D0208

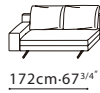

C01D0209



C01D0210

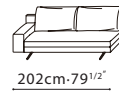

C01D0211

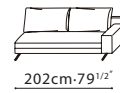

C01D0212
+C07D0231

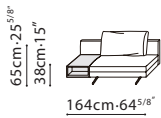

C01D0213
+C07D0231

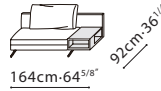

C01D0214
+C07D0231



C01D0215
+C07D0231

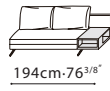

C01D0216
+C07D0231

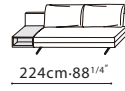

C01D0217
+C07D0231

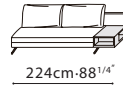

C01D0218
+C07D0231

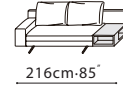

C01D0219
+C07D0231

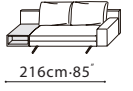

C01D0220
+C07D0231

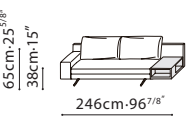

C01D0221
+C07D0231

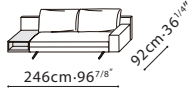

C01D0222



C01D0223

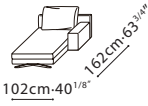

C01D0224



C01D0225

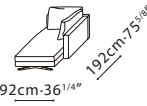

C01D0226
+C07D0231

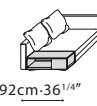

C01D0227
+C07D0231

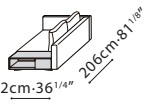

C01D0228
+C07D0231

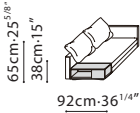

C01D0229
+C07D0231

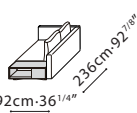

C01D0230

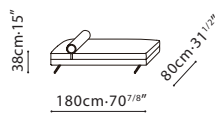

C81D0204



C07D0231

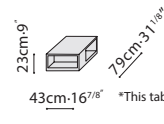

*This table is only available in Mocha Eucalyptus